

USER INSTRUCTIONS



INTERIOR BLINDS

930167_EN



CONTENTS

1.	BASIC INFORMATION	2
1.1	INFORMATION ON USING YOUR INTERIOR BLIND	2
2.	EXPLANATION OF NOTES	3
3.	VALIDITY	3
4.	SAFETY	3
5.	INTENDED USAGE	3
6.	PRODUCT INFORMATION	3
7.	OPERATION	4
7.1	GENERAL SAFETY INSTRUCTIONS FOR THE USAGE OF INTERIOR BLINDS	4
7.2	INTERIOR BLIND WITH BALL CHAIN/ENDLESS CORD	4
7.3	INTERIOR BLIND WITH PULL CORD AND TWISTING ROD	4
7.4	INTERIOR BLIND WITH CRANK MECHANISM	4
7.5	INTERIOR BLIND WITH MOTOR	4
8.	GENERAL NOTES	5
9.	MAINTENANCE AND CARE	5, 6
10.	THE FOLLOWING POINTS MUST BE OBSERVED	7
11.	DISASSEMBLY	7

1. BASIC INFORMATION

Thank you for purchasing this **WOUNDWO** product.

Taking heed of the user instructions before using this product is essential for trouble-free operation.

It is important that these instructions are followed to ensure the safety of those using the product. It is imperative that indications given in the user instructions are observed. Non-compliance with these instructions releases the manufacturer from its duty to provide warranty. Please follow the explanations on the product and on the packaging.

We request that all manuals are kept (assembly and user instructions) and passed on to the new owner in case the interior blind is sold.

1.1 NOTES ON USING YOUR INTERIOR BLINDS

Generally, blinds are very simple and comfortable to use. In order to use the blind without any difficulties, it must be ensured beforehand that the curtain can move freely, i.e. that there is nothing in the way when it is brought down and that there is no resistance present when pulling it back up. If this is not the case then the curtain could be damaged or the pull cords could become twisted. If the curtain is blocked during use then the cords or the motor and the operating elements could be damaged! Blinds provide excellent protection from the sun as well as some degree of protection against prying eyes. If you feel that people can look into your room from below via the obliquely turned slats, then you can turn the slats inside so that the angle of light incidence is directed upwards. Usually, products from WO&WO are made in accordance with generally valid regulations and norms, and guidelines with regard to closing behaviour and operating forces are adhered to. A lowered blind does not protect either a person or an animal from falling out of the window.

Improper use can impair the functionality and the safety of your blind. The warranty claim becomes invalid in case of improper use - please also see our General Terms and Conditions of Delivery.

2. EXPLANATION OF NOTES

Safety instructions and important information can be found in corresponding parts of the text. These are denoted with a symbol.



This symbol denotes information which is important for the safety of people, animals and goods, or for the function of the interior blind.



This symbol denotes important product information for the user.

3. VALIDITY

These instructions are valid for the following **WOUNDWO** interior blinds:

ISODESIGN, ISODESIGN COLOR, BELLA, SLOPE, EUROPA, SONETT

4. SAFETY



All **WOUNDWO** interior blinds are constructed and produced in accordance with the regulations of norm EN 13120. Nevertheless, when operating the systems, non-compliance with the corresponding instructions can result in dangers for users and animals or damage to the product or other goods.



Only use the product in a technically fault-free condition as well as in accordance with the intended use, fully aware of safety and danger and in observance of the operating instructions. In particular, promptly correct disruptions which can compromise safety.

5. INTENDED USAGE

WOUNDWO interior blinds are mainly used to protect against heat and the sun as well as to regulate daylight. In addition, **WOUNDWO** interior blinds also guarantee façade and sight protection. A use other than or above and beyond that is deemed to be not in accordance with the intended use.

The manufacturer/supplier is not liable for damages resulting from non-compliance.

No changes, expansions or modifications must be made to **WOUNDWO** interior blinds without permission from the manufacturer. Additional loads on the interior blind due to suspended objects can lead to damage and are therefore not permissible. Interior blinds which are not in optimal condition must be exchanged immediately at a specialist dealer.

Only **WOUNDWO** approved spare parts must be used to replace worn out or defective parts. It cannot be guaranteed that parts from other suppliers are constructed and produced in such a manner that is safe or suitable for the demands of that component. Assembly and maintenance work must only be carried out by qualified companies or staff.

WO&WO Sonnenlichtdesign GmbH & Co KG accepts no responsibility for damage arising as a consequence of usage that is not for the intended purpose.

6. PRODUCT INFORMATION

TECHNICAL DATA

Technical details regarding the interior blind can be seen in the current specialist trade catalogue at your specialist dealer.

DATA FOR THE ELECTRIC DRIVE

PARAMETERS	VALUE
Mains Voltage	24 V DC, 230 V AC (depending on drive)
Current consumption	0.21 - 0.68 Ampere (depending on drive)
Power consumption	6 - 49 Watt (depending on drive)
Protection class with the electric drive	IP 20, IP 40 (depending on drive)
Continuous operation of the motor	Approx. 4 minutes (depending on the drive and the ambient temperature)



The electric motor is not designed for constant use. After being used several times in succession, the thermal protection activates and the motor switches itself off. After a few minutes, the motor is ready for operation once more, but the activation time is considerably reduced.

7. SYSTEM OPERATION

7.1 GENERAL SAFETY INSTRUCTIONS FOR THE USAGE OF INTERIOR BLINDS



Using the interior blind is only allowed when it is ensured that there are no obstacles in the area where the interior blind will move.



When the motor is operating, surfaces or individual interior blind components can warm up considerably, which may lead to burns if touched directly.



The automatic control unit must be switched off when working on the unit for reasons of safety. In addition, it must be ensured that the system cannot be inadvertently operated manually or automatically moves up or down. The electricity supply needs to be stopped for this purpose, e.g. remove the fuse or remove the plug coupling on the motor from the electricity supply (requires an electrician). In case of manual use, it must be made clearly visible on the operating elements (switch, button, remote control) via a corresponding notification that work is being carried out on the system and that it must not be used.



Foreign matter or heavy soiling, especially where there are moving parts, should be removed immediately, otherwise there is a risk of damaging or destroying the interior blind.



When disassembling or exchanging the blind, please follow the valid waste disposal regulations.

7.2 INTERIOR BLIND WITH BALL CHAIN/ENDLESS CORD

The location or position of the slats is determined by pulling the chain/cord equally on both sides. To prevent damage, breakage of the chain and allowing the curtain to fall in an uncontrolled manner must be avoided at all costs.

7.3 INTERIOR BLIND WITH PULL CORD AND TWISTING ROD

A light pull on the pull cord towards the centre of the blind releases the cord lock and the blind falls. Simply lead the cords away to stop the blind. It is recommended that the slats are horizontal when lowering or raising the blind. Simply turning the twisting rod changes the position of the slats. As several cords are used, unequal pulling on the cords can lead to the curtain running incorrectly.

7.4 INTERIOR BLIND WITH CRANK MECHANISM

Pulling up or down or turning the slats is done centrally by means of a crank. Use of the blind must be made without excessive force. The crank must only be operated in the direction that is provided.

When reaching the end stop, do not try to turn the crank any further.



When operating the crank, care should be taken to ensure that this does not touch the wall, as this can lead to damage in the upper area where the crank is attached (breakage of the plastic ring).

7.5 INTERIOR BLIND WITH MOTOR

Due to a lack of perception, it is especially important to check the free fall of the curtain before use. This applies in particular to systems which are operated via automatic control elements (sun sensors, temperature sensors, timers etc.).

If usage takes place several times in quick succession, then the thermal circuit breaker can kick in, meaning that the motor may not run (lasts a few minutes) until the circuit has cooled down. In case of malfunctions after a thunderstorm (indirect lightning strike), simply switching off and then switching on the corresponding circuit can restore functionality.

Connection of the drive and additional devices must only be carried out by licensed electrical companies.

-  When handing over the system, corresponding training by a qualified member of staff on how to correctly use the electric drive must take place. The assignment of the individual operating elements is also explained as part of it.
Use of interior blinds must only be done by people who have been instructed in the use of such blinds by qualified staff.
-  Do not allow children to play with the operating equipment (switch, buttons, remote controls) at all costs! Keep all remote controls out of the reach of children.
-  Work on electrical systems must only be undertaken by a specialist electrician.

8. GENERAL NOTES







Textiles are subject to wear and tear and can undergo technical, natural changes due to UV radiation, heat, and water. These may cause stretching, shrinkage and bleaching and hence potentially affect the function (closing behaviour, incorrect running) of the blind.

Blinds must not be exposed to building moisture over a prolonged period in order to prevent corrosion damage. Condensation water from ready-mixed mortar or coatings can lead to corrosion damage. Regular airing and drying out of condensation water on metal parts maintains the quality of the blind.

Colour droplets which appear on the product due to painting must be immediately removed with a damp cloth, otherwise the proper functionality of your pleated blind cannot be guaranteed.

All mechanical parts of the blind are hard-wearing, solidly constructed and very easy to use. However, if you encounter any problems or flaws, please do not try to solve the problem yourself, but consult your nearest **WOUNDWO** dealer. Your nearest dealer can be found at www.woundwo.com

9. MAINTENANCE AND CARE

-  As part of cleaning and maintenance work on the interior blinds, no system components or covers must be opened or removed. If this is necessary, then contact a specialist dealer.
-  Large deposits of dirt can lead to stiff movement or to damage, and thus reduce the working life of the product. For this reason, it is advised to regularly clean dirt off the surface of the curtain.
Also ensure that the system cannot be unintentionally operated manually or inadvertently goes up or down.
-  Never lubricate the motor or the mechanisms in the interior blind!
If the blind becomes extremely stiff or loud noises occur, contact a dealer.
-  Do not try to repair electrical parts yourself - acute danger to life!
In case of malfunctions, contact a specialist dealer.
-  For interior blinds which can be operated outside the field of view, the user must take suitable precautions to prevent unintentional operation of the interior blind during repair or maintenance work.
-  Exchanging defective or worn-out parts must only be done with approved **WOUNDWO** spare parts, otherwise any warranties or guarantees will be invalid.
-  So that your newly purchased blinds will give you years of use and that the advantages of this individual method of protecting from the sun can be fully enjoyed, we recommend that you carefully read these care and usage instructions and take note of all following points.

Mechanical and drive elements are made from plastic or corrosion-resistant steel and thus do not require maintenance.

Mild soiling

Cleaning takes place on site. Dismantling the blind is not necessary. Carefully rinse coated elements such as the upper or lower rail, slats or plastic parts with a soft sponge and lukewarm water. Cleaning with a cleaning agent with an antistatic effect prevents the area from being soiled again.

Before cleaning, ensure that there are no impurities on the painted metal parts that may scratch or abrade.

In case of heavily soiled pleated blinds, contact your dealer or a suitable company specialising in the cleaning of buildings.

ATTENTION:

- Do not use any kinds of abrasive agents e.g. pastes or liquids etc.
- Do not use any mechanical aids e.g. scrapers or spatulas etc.
- Do not use any high-pressure steam cleaners
- Do not use any solvents or alcohol (white spirit).

CLEANING

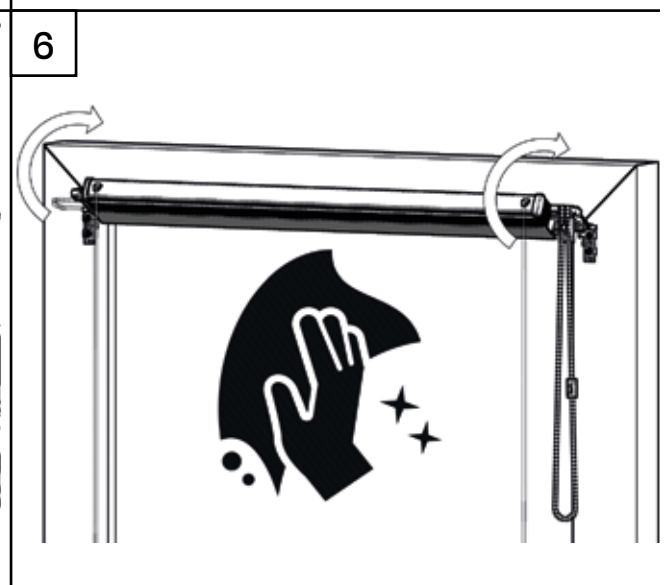
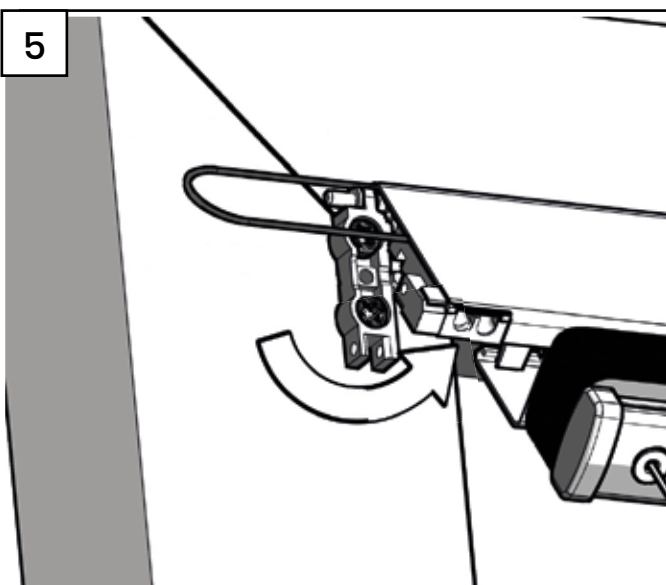
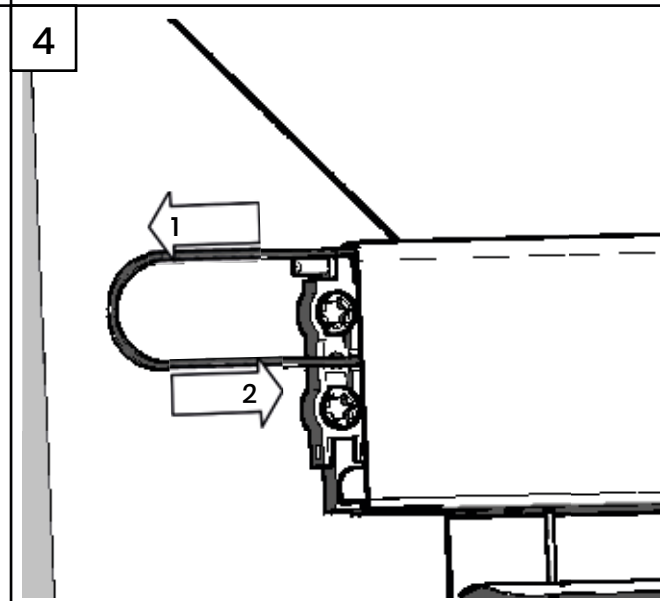
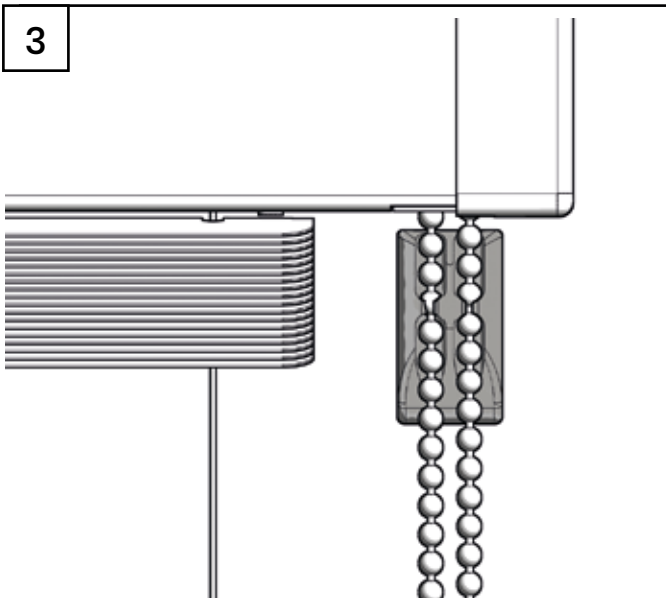
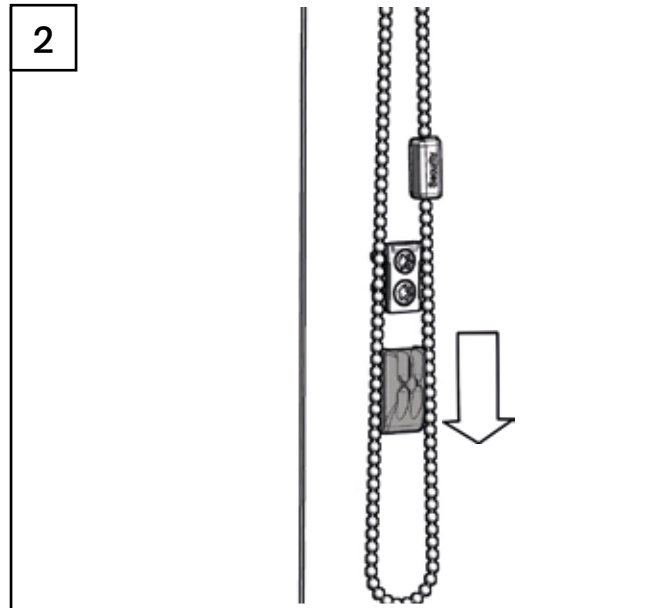
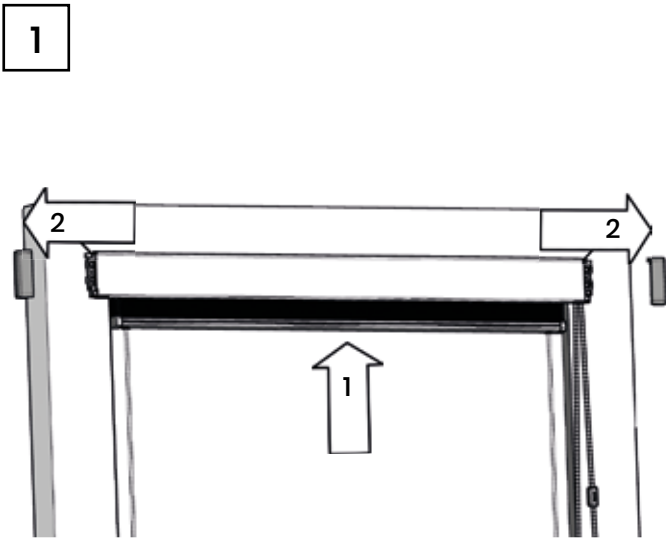

10. THE FOLLOWING POINTS MUST BE OBSERVED



To avoid thermal breakage of glass and the build-up of condensation, sufficient aeration and ventilation of the room, the correct selection of glass and professional installation are all required.



We would like to point out that insufficient ventilation and aeration may cause a build-up of condensation and also a build-up of heat. We cannot accept any guarantees for pleated blinds that have been damaged in such a manner. This also applies to glass breakages as a consequence of heat build-up or unsuitable characteristics of the glass.

11. DISASSEMBLY



Improper disassembly of the interior blind can result in damage to the product or injury. Only allow disassembly to be carried out by a specialist.

Information and tips on correctly dismantling the interior blind can be found in the respective assembly instructions.

